

Installing & Adjustment manual

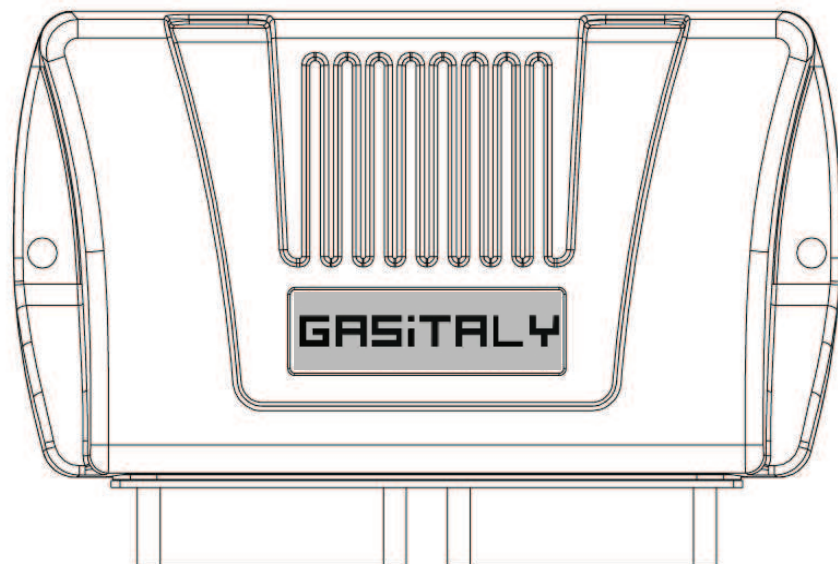

Multipoint Sequential
LPG/CNG Injection System

VER. 02

November
2011

This kit contains:

1. ECU
2. Wire harness
3. MAP sensor
4. Turn-over level switch
5. Temperature sensors - 2 pcs
6. Installing and adjustment manual

Recomendation data for nozzle sizes according to the engines power when using injectors RAIL / VALTEK:

For pressure 1,5 bar \pm 0,2 bar

		4 cylinders nozzle hole						
		1,2	1,4	1,6	1,8	2,0	2,2	2,5
power in p.h.	40 - 60							
	61 - 79							
	80 - 100							
	101 - 120							
	121 - 137							
	138 - 160							
	161 - 180							
	181 - 200							

		6 cylinders nozzle hole								
		1,4	1,6	1,8	2,0	2,2	2,5	2,8	3,0	3,5
power in p.h.	140 - 160									
	161 - 180									
	181 - 210									
	211 - 240									
	241 - 270									
	271 - 300									
	301 - 330									
	331 - 360									

Table for calculating the size nozzle RAIL/VALTEK (for example: 160 h.p. for 4 cylinders is 40 h.p./cyl.)

For pressure 0,8 bar \pm 0,1 bar

		4 cylinders nozzle hole						
		1,6	1,8	2,0	2,2	2,5	2,8	3,0
power in p.h.	40 - 60							
	61 - 79							
	80 - 100							
	101 - 120							
	121 - 137							
	138 - 160							
	161 - 180							
	181 - 200							

		Calculating table nozzle hole						
		1,2	1,4	1,6	1,8	2,0	2,2	2,5
15 h.p./cyl.	15							
	20							
	25							
	30							
	35							
	40							
	45							
	50							

ATTENTION: For vehicles with full grup engines it is necessary to use one or two bigger sizes than those from table above.

Exemplary data about the type of nozzles for VALTEK/RAIL injectors with some cars

Year	Make/Model	Engine Type	Displacement ms	Power kW	Number of Cyl.	Power per Cyl.	Nozzle mm
1	1996 MAZDA 626		2,5		6	0,0	1,9
2	1998 MERCEDES	E280	2,8	150	6	25,0	2,0
3	2005 MITSUBISHI LANCER	4G18	1,6	72	4	18,0	1,6
4	1997 MERCEDES C230		2,3	110	4	27,5	2,0
5	2004 OPEL ASTRA		1,6	74	4	18,5	1,5
6	1999 CITROEN XM-2 / RGX	(XU10J2TE)	2,0	110	4	27,5	1,9
7	1998 BMW 318i		1,9	103	4	25,8	1,7
8	2000 SCODA OCTAVIA	ADY	2,0	85	4	21,3	1,9
9	2001 SUZUKI GRAND VITARA	H271	2,7	94	6	15,7	1,7
10	2003 FORD FOCUS	CDDA	1,6	71	4	17,8	1,5
11	1999 TOYOTA PICNIC	3S8	2,0	94	4	23,5	1,7
12	2005 VAZ 2115		1,5	56,4	4	14,1	1,3
13	1999 VW TRANSPORTER	AVT	2,5	85	5	17,0	1,9
14	1995 MITSUBISHI PAJERO	6G74	3,5	153	6	25,5	2,0
15	2000 SUBARU LEGACY	EJ25	2,5	123	4	30,8	2,2
16	2002 VOLVO SC70	B5254T	2,5	155	5	31,0	1,9
17	1998 AUDI A6	ALF	2,4	121	6	20,2	1,8
18	1998 SEAT ALHAMBRA	ADY	2	85	4	21,3	
19	1998 BMW 316i	M43	1,6	75	4	18,8	1,8
20	1999 SAAB 9.5	B235E	2,3	125	4	31,3	2,2

Preparations for the system settings

After all parts of the system have been properly installed, detailed check of the mechanical and electrical parts of the system must be done separately. When the mechanical installation is properly done check of the electric connections of the following elements is followed:

- **Powering both electric valves** (particular attention should be granted to their ground witch must be independent from the connection of the measuring sensors with a separate cable to a substantial ground from the body of the car or directly from the terminal of the accumulator)

- **Cut-off of the petrol injectors** (in some cars an inversion of the entering connectors is required – connected to the petrol computer). When connecting the LPG electronic control unit (ECU) with cables without injector connectors (particularly with Japanese, Americans and Korean cars) be careful for the sequence and the equality of the connections for every separate cylinder

- **Supply of the injector rail** – in this case the possibility for a mistake is reduced to the minimum. Attention should be granted to sequence of the cylinders. Much more attention should be granted to the ground connection of the rail. Here should be used cable terminals and screws with nuts. In some places the paint, dirt and anticorrosion plate must be cleaned where is needed.

- **Connecting of the sensors** – an independent supply is provided by separate cables, terminals and connectors directly from the ECU. It is important to know that the ground of these sensors should not be used for supplying other elements of the system – injectors, valves, common power of the ECU etc.

- **Level meter with turnover switch and buzzer** – separated cables are provided for them directly from the ECU and from the level meter sensor, mounted on the gas tank.

- **Interface connection between the programming computer and the LPG ECU** – special cable and connectors

- **Supplying and information cables** – “+12V”, “+12V engine on”, “+12V from the fuel pump” and “ground cable”. The ground cable should be connected directly and stable to the terminal of the battery and the other 3 are not to be connected together, because they have their own object. The “+12V engine on” cable should not be mistaken with the “ACC” terminal.

When the mechanical and electrical parts are properly installed you can go to starting the engine on petrol, warming it up, and primary checks and settings. To guarantee the automatic tuning some general car data is being required.

Legend
Menu tuning PIC.1

- 1 - RPM meter
- 2 - Petrol injection time in milliseconds (ms)
- 3 - LPG injection time in milliseconds (ms)
- 4 - Lambda sensor curve (in down left corner current value in volts)
- 5 - Switch for lambda sensor range (0-1V), (0-5V) – most cars are supplied with 1V sensor
- 6 - Button to restore factory settings
- 7 - Fuel mode (Petrol/LPG)
- 7a - Turn on - turn off cylinder buttuns
- 8 - Button LPG – it is working when reducer temperature is reached or 10 seconds after the engine is on
- 9 - GAS pressure (0-3bar) (double pressure sensor VPS05)
- 10 - Vacuum (-1 – 2bar)
- 11 - Current temperature on the reducer
- 12 - Button Petrol
- 13 - Force GAS – you can switch over to LPG no matter of the temperature
- 14 - Fuel mode (Petrol/LPG) lamp

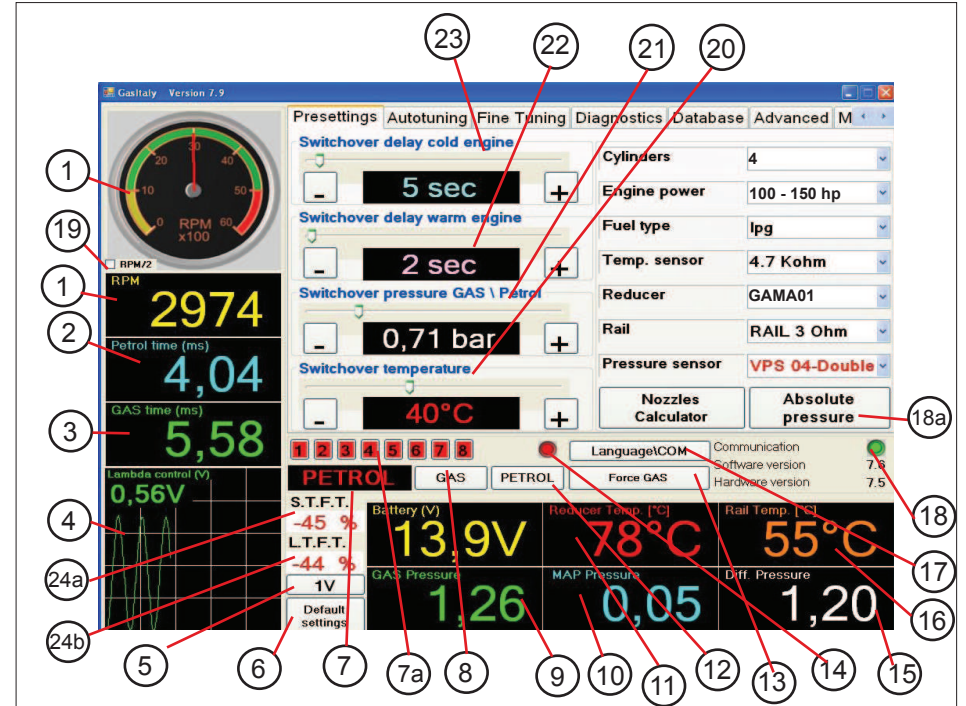

Pic.1

- LPG mode - lamp is green when the engine is working on LPG, lamp is blinking when the reducer temperature is not reached
- Petrol mode - lamp is red
- 15 - Differential pressure (0-3bar)
- 16 - Current temperature on the injector rail
- 17 - Button for language and “COM Port” setting.
- 18 - Communication - lights on green when there is connection with the engine’s ECU, lights red when is missing or is incorrect
- 19 - RPM divider - full grup.
- 20 - Slider for setting the switch-over temperature Petrol/LPG
- 21 - Slider for setting the switch-over pressure from LPG to Petrol (when the LPG tank is empty)
- 22 - Slider for setting switch-over time at warm engine. If it is set at 1 sec. the engine starts directly on GAS.
- 23 - Slider for setting switch-over time at cold engine
- 24a - Short fuel trimmer
- 24b - Long fuel trimmer

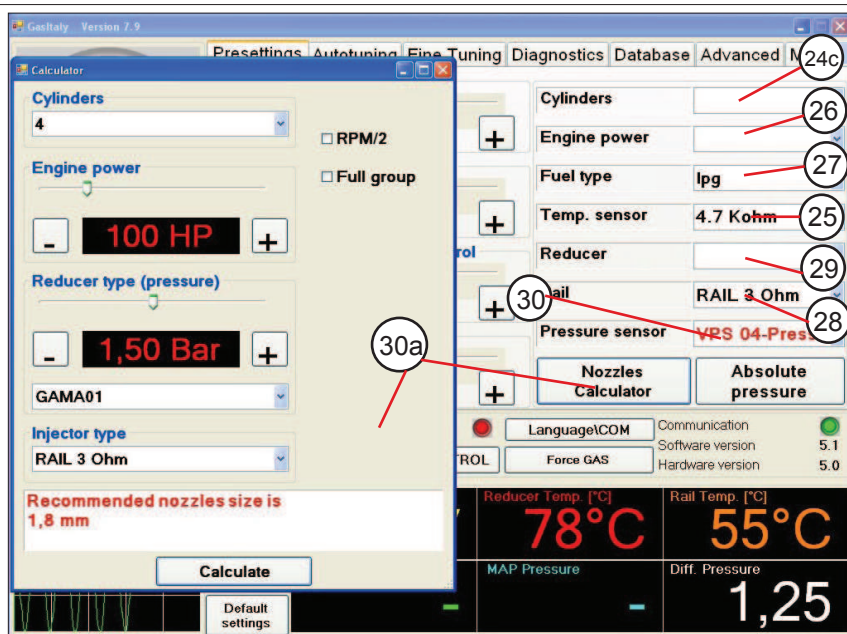

Pic. 2 Presettings

- 24c - Number of cylinders
- 25 - Reducer temperature sensor type
- 26 - Engine power-
- 27 - Fuel type
- 28 - RAIL type
- 29 - Reducer type
- 30 - Pressure sensor type
- 30a- Nozzles calculator

Presettings of the system

It is necessary to select from the first menu “PRESETTINGS” number of the cylinders, power in h.p., the type of temperature sensor of the reducer, pressure of the automatic switch-over “LPG/Petrol”, time for switching over after warming up the engine from “Petrol/LPG” with cold and warm engine, temperature of the automatic switch-over from Petrol to LPG..

After completing the initial settings you can select menu 4 – “DIAGNOSTICS” (Pic. 5) in order to check to correct cut-off of petrol injectors, their sequence and proper temperatures. If there is a sequential type of control of the petrol injectors you’ll see on the left side of the screen and on the round display the real RPM, also you’ll see sequential movement of the colored squares

in the right side of the screen (42) for each cylinder separately. When the control is parallel 2x2 or “full group” you’ll see it clearly on screen – Petrol injectors sequence. In this case you have to switch the RPM to real values by using the checkbox in RPM meter (pic1 - 19). If there is a missing coloured square for some cylinder you have to check the electrical connections for petrol injectors, if all the squares are missing – you have to turn over the input connectors to petrol ECU side..

When the engine is “full group” (semi sequential) you can click on the check box. By that the LPG injectors will inject fuel 2 times less (over tact). In this case you have use bigger size calibrated nozzles than standard.

Until now all the operations are executed in “Petrol” mode, which is indicated by a red light and a label “Petrol”. When the temperature is minimum 20°C you can switch over in “LPG” mode looking for the differential pressure to be near to 1.5bar. When you have normal RPM in idle, pressure, working engine with increased temperatures over 70°C on the reducer and at least 50°C on LPG rail, you can go to auto tuning mode. Anyway, from the menu “DIAGNOSTICS” (Pic. 6) you can switch each cylinder separately on LPG, looking for normal engine behavior in this case you can catch eventually not working LPG injector or improper sequence which could be easy normalized by using the injector terminals.

The real sign for improper sequence of the cylinder arrangement you can find when switch-over LPG/Petrol or vice versa in case the petrol injector times in “Petrol” mode and in LPG mode are equal. You can adjust this equality by using the arrows near by the blue colored row in the “FINE TUNING” (Pic. 4) menu, waiting near 10 seconds and switching over a few times Petrol/LPG. And if after this procedure the engine is still shaking for a second when switchover the fuels you must check the sequence of the LPG injectors. Rarely the mistake could be from the hoses row to intake manifold, it is easy to correct by rearranging the connectors on the LPG rail. If the engine is working well you can go to “Autotuning mode” (Pic 3). It has to be done when all the power consumers are switched off (A/C, window, seat and mirror heaters, lights, cooling fan of the radiator). The engine must reach minimum 60°C and you have to sure by the lambda sensor data that the petrol ECU regulates. Than the AUTOTUNING procedure can start by pressing the button (31). Follow the instructions in a few steps that will appear in red colour in the field.

Step 1 - Calibration at idle mode. Step 2 - Force engine several times (5-6) to get maximum petrol times. Step 3 - reach 3000 +/- 500 RPM without load and keep it permanent, you can push the “next step” button. After 20-50 seconds in the dark field (34) you’ll see the number between 1-2.5 and message “OK” under it, which means the auto tuning is finished. There is a possibility to choose 3 different ways of driving depending on the driver’s preferences, conditionally called “Economic”, “Normal”, “Sport”. They could be chosen by using the checkboxes in screen (33). In case the “Auto tuning” mode is not working, you’ll see the message into screen (35). After eliminating the problem you can start the “Auto tuning” mode again.

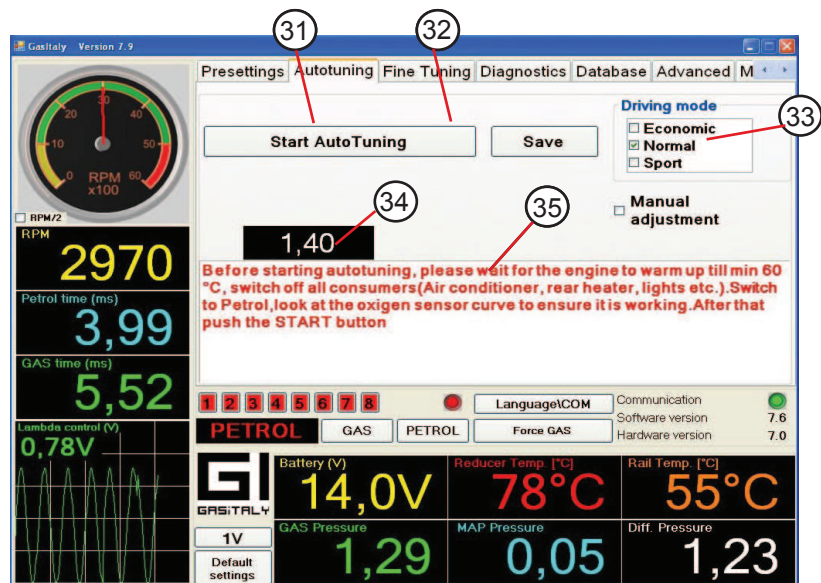

Pic. 3 Autotuning

- 31 - Start Autuning button.
- 32 - Button “Save” for generated coefficients when auto tuning is completed
- 33 - Driving mode
- 34 - Calculated coefficient from “Auto tuning” mode
- 35 - Field for “Auto tuning” messages

MANUAL ADJUSTMENT

Sometimes if the automatic adjustment does not pass, so you have to adjust the coefficients manually. The steps are the following:

1. The engine runs on idle in petrol. In the upper square you see moment petrol injection time. When the petrol ECU starts vary lambda sensors you can switch on LPG.

2. (Pic.3a) - In the bottom square is shown the petrol injection time when the engine runs on LPG. You have to reach both values almost equal – it could be done by slider - changing the current coefficient, push the “SAVE” button to record into the ECU. For more precise adjustment you can do it by using the coefficients in the menu "Fine tuning" when the car is moving on different road types, to ensure more loads for the engine and speeds. In the menu you have push button “calculate map”. This is the connection between the linear adjustment with 16 coefficients (36) and the 3-size map, which is table of coefficients, depending from petrol time and RPM. This button give you possibility to switch

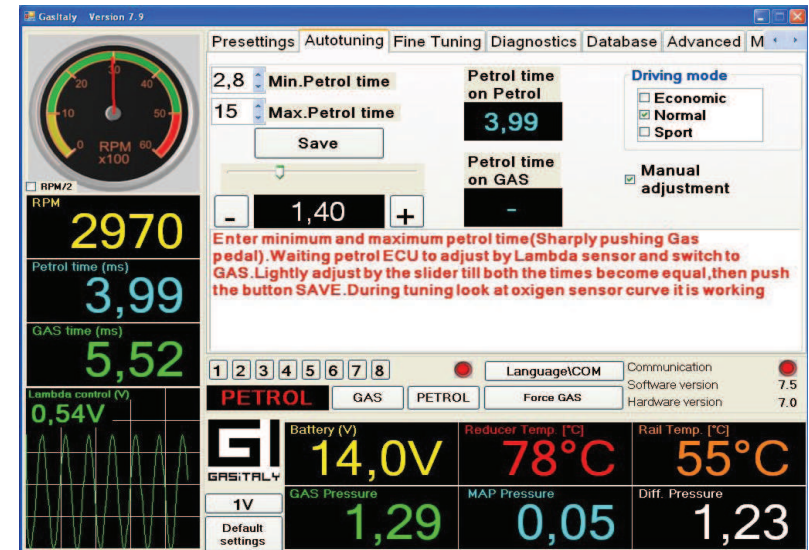

Pic. 3a Autotuning

from easy to more detailed adjustment. Driving the car with constant RPM and gas pedal (fixed TPS), you see the blue line on the petrol inj. time. You have to switch from petrol to LPG and move with arrows up or down current coefficient till the valve, when the petrol inj. time is equal on petrol and LPG running. The same procedure for different petrol times will give you more precise adjustment. By arrows of the neighbour coefficients you have to adjust them so, the red curve 37 is slight falling down to the high.

You also have to make fine tuning when you notice the change in the way of working of the engine (losing power or increasing the consumption of LPG fuel).

From the “FINE TUNING” (Pic.4) menu use the checkbox labeled “Normal”. On the screen you see 16 coefficients; the working in each moment is colored in blue. Ensure permanent load, RPM and throttle position (gas pedal) switch-over from “Petrol” to “LPG” and if the petrol injector times are changing, correct the colored in blue coefficient simultaneously with switching over. If the petrol time when turn over from “Petrol” to “LPG” is increased you have to increase the coefficient and vice versa till you reach the equality of these petrol times. It is recommended to use this procedure for more load conditions of the engine (at least 6-10). If you didn’t manage to cover all driving modes using the arrows adjust all uncalculated coefficients near to the calculated ones. Looking over the curve (37), you’ll try to make this curve smoother. (Pic.4)

36 Pic.4 Fine Tuning

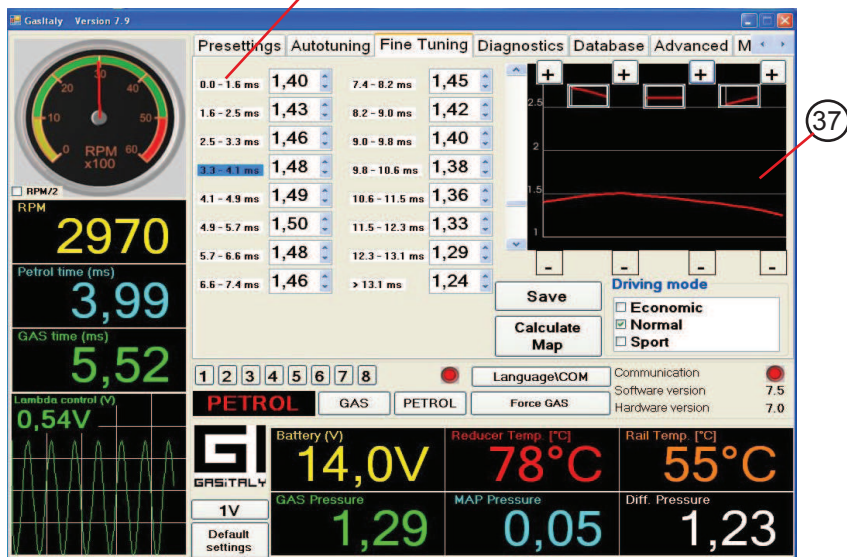

- 36 - Current coefficient (colored in light blue)
- 37 - Coefficient diagram
- 38 - Sequence of the single cylinders
- 39 - Time between cleaning cycles
- 40 - Switch over separately the cylinders from GAS to Petrol and from Petrol to GAS (red - Petrol, green - GAS)
- 41 - Switch on/Switch off GAS valve
- 42 -Sequence of single injectors
- 43 - Statistics

“DATA BASE”

This screen is divided in two: “CAR DATA” and “CLIENT’S DATA” (Pic.6)
“CAR DATA” – if you want to create new folder with adjustment information for a car, after you fill lines “CAR”, “MAKE”, “ENGINE TYPE” etc., by “CAR RECORD” button you could save the details for the given car, the software automatically creates the fails with the names of the car (Ford, Opel, Honda etc). The fails are with extension “*.LPG” or “*.CNG” depending on the first menu “PRESETINGS”. So the created fails you can use to adjust the next car types from previous ones. By button “LOADING DATA” you choose corresponding file, on the screen will appear button “LOAD in the ECU” and by pressing it you can load the adjustment parameters into the ECU.

“CUSTOMER’S DATA”:

After the adjustment of the system is made it is possible to save the information for about the client. You have to fill the lines, by button “SAVE” you save information into a different file, useful for the installer. The names of the

38 39 40 41

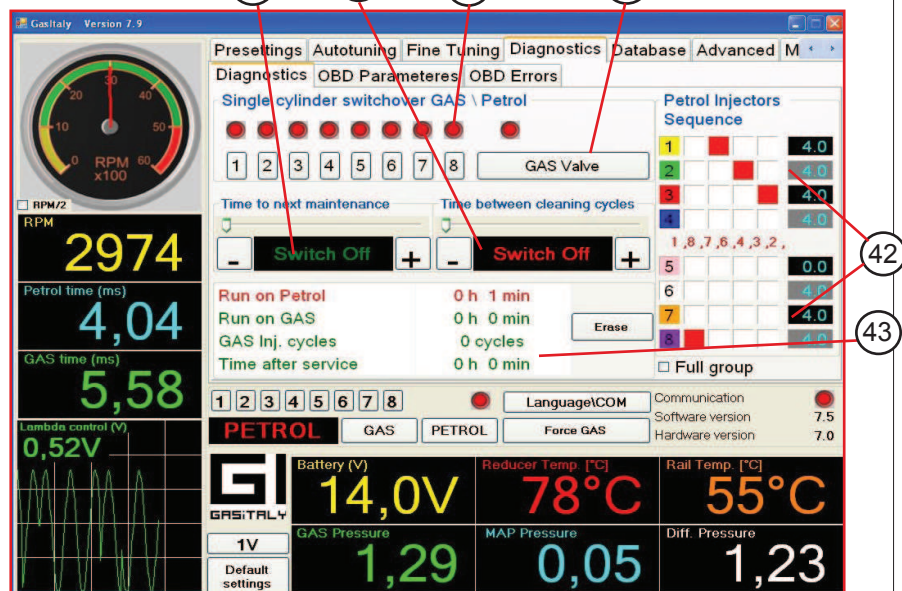

Pic.5 Diagnostics

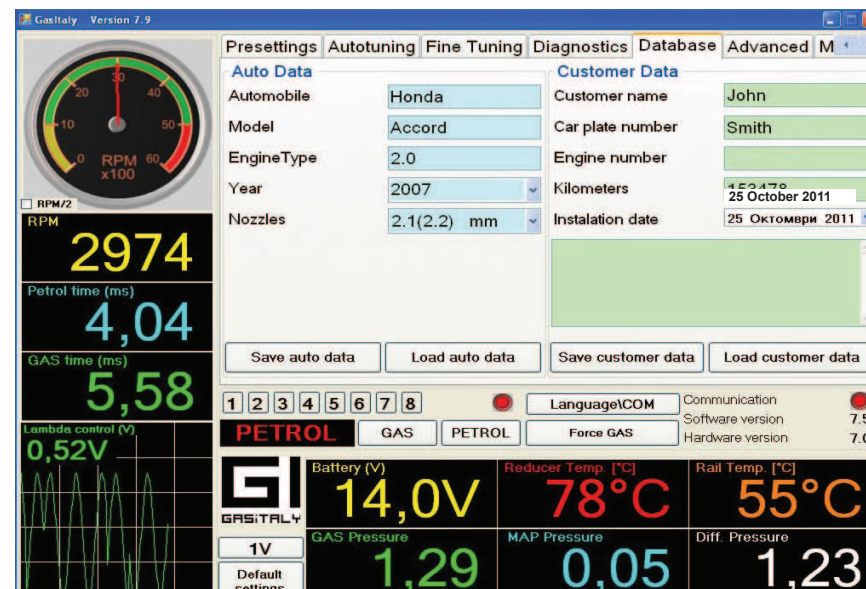

Pic. 6 Database

LPG petrol turn-over switch,
level meter and buzzer

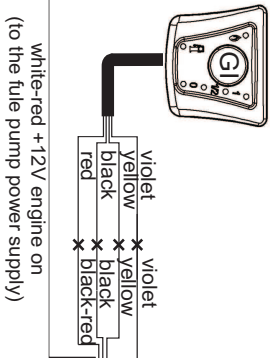

Installation diagram GASITALY /OBD/ LPG and CNG 3, 4,5,6, 8 cyl.

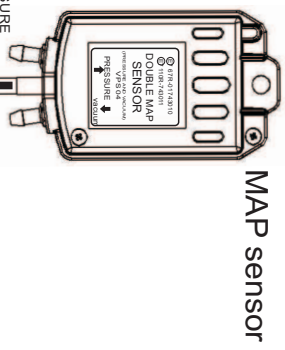

to PC

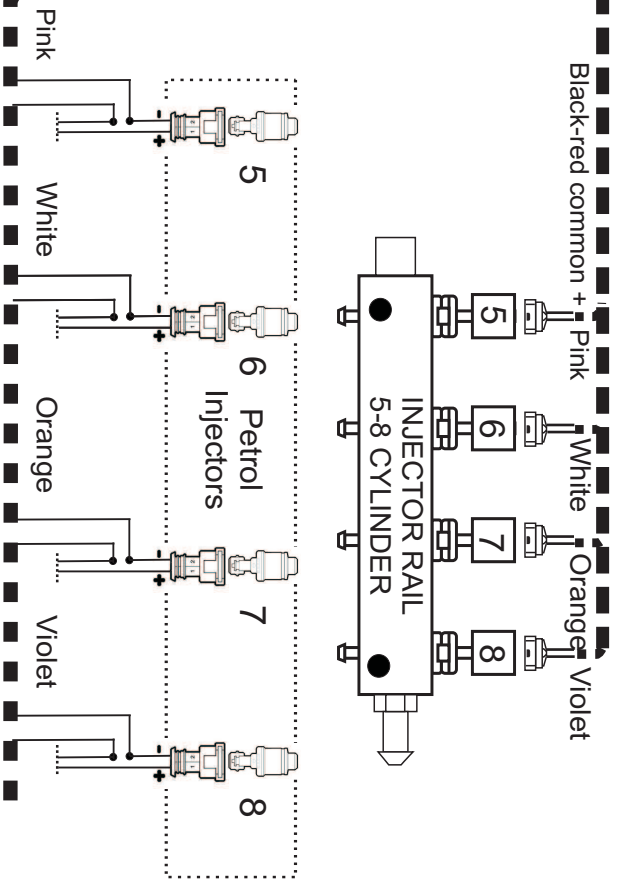
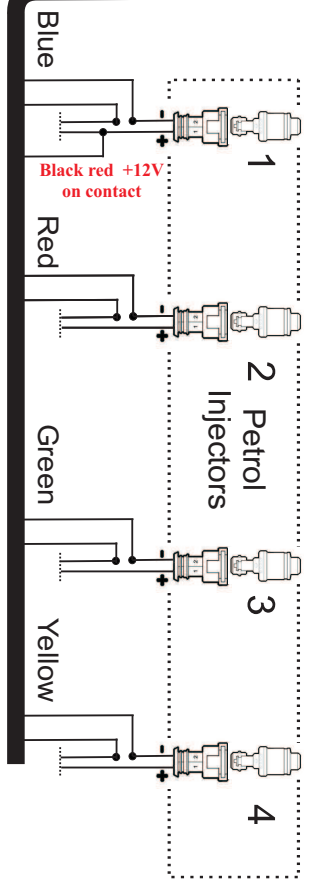
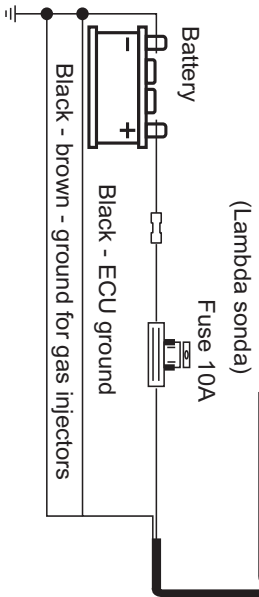
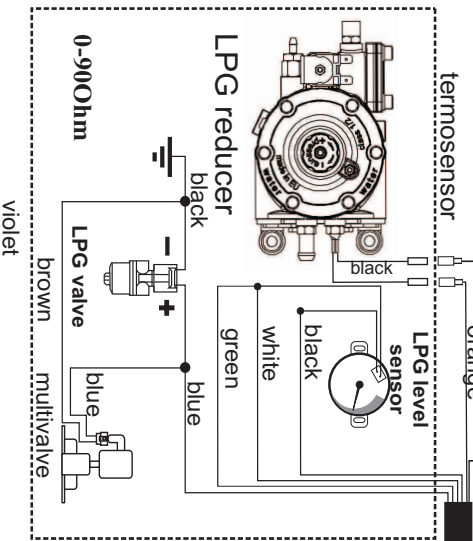
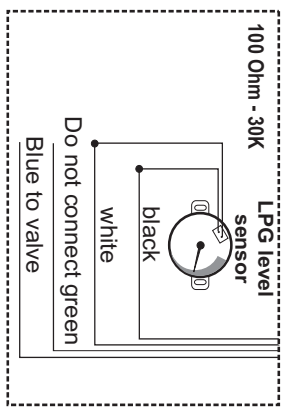
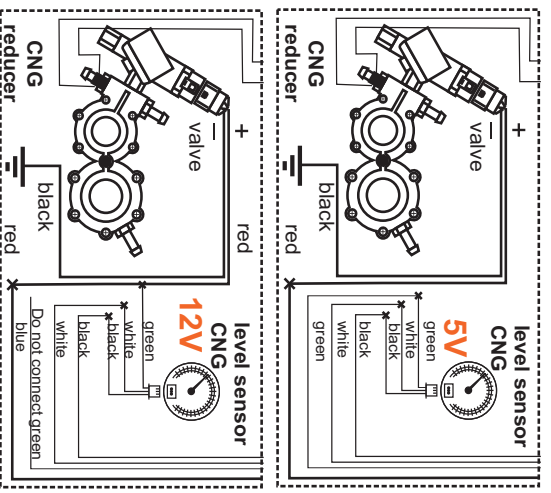
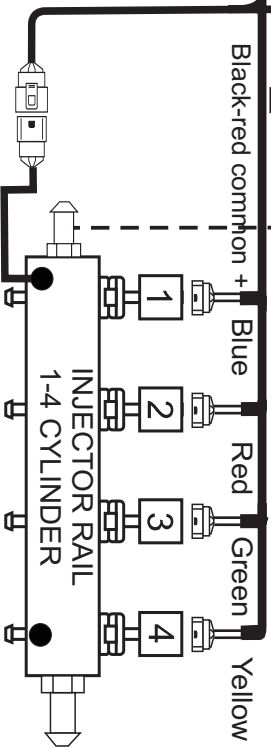

Yellow - CAN High
Black-yellow CAN Low
White K Line
Black-green L Line

ONLY IN OBD VERSION

Connector	ULTRAGAS OBD
J1962	YELLOW
6	Black-yellow
14	White
7	Black-green
15	L Line

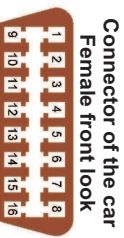

Connector of the car
Female front look

The scheme of the wire harness

1.	BLUE	GAS INJECTOR 1-
2.	RED	GAS INJECTOR 2-
3.	GREEN	GAS INJECTOR 3-
4.	YELLOW	GAS INJECTOR 4-
5.	PINK	GAS INJECTOR 5-
6.	WHITE	GAS INJECTOR 6-
7.	ORANGE	GAS INJECTOR 7-
8.	VIOLET	GAS INJECTOR 8-
9.	BLACK/BROWN	INJECTOR GND-
10.	RED/BLACK	+INJECTORS FOR 6 AND 8 CYL.-
11.	RED/BLACK	+INJECTORS-
12.	BLUE	LPG VALVE-
13.	RED/BLACK	+ ON CONTACT 1 CN-
14.	RED	+12V FROM ACCUMULATOR-
15.	BLUE	CUT PETROL INJECTOR 1 TO PETROL INJECTOR CUT1_A
16.	BLUE	CUT PETROL INJECTOR 1 TO CAR'S ECU CUT1_B
17.	PINK	CUT PETROL INJECTOR 5 TO PETROL INJECTOR CUT5_A
18.	PINK	CUT PETROL INJECTOR 5 TO CAR'S ECU CUT5_B
19.	RED	CUT PETROL INJECTOR 2 TO PETROL INJECTOR CUT2_A
20.	RED	CUT PETROL INJECTOR 2 TO CAR'S ECU CUT2_B
21.	WHITE	CUT PETROL INJECTOR 6 TO PETROL INJECTOR CUT6_A
22.	WHITE	CUT PETROL INJECTOR 6 TO CAR'S ECU CUT6_B
23.	GREEN	CUT PETROL INJECTOR 3 TO PETROL INJECTOR CUT3_A
24.	GREEN	CUT PETROL INJECTOR 3 TO CAR'S ECU CUT3_B
25.	ORANGE	CUT PETROL INJECTOR 7 TO PETROL INJECTOR CUT7_A
26.	ORANGE	CUT PETROL INJECTOR 7 TO CAR'S ECU CUT7_B
27.	YELLOW	CUT PETROL INJECTOR 4 TO CAR'S ECU CUT4_B
	YELLOW	CUT PETROL INJECTOR 4 TO PETROL INJECTOR CUT4_A

29.	BLACK	ECU GROUND-
30.	BLACK	GROUND TEMP. SENSOR INJECTOR RAIL-
31.	BLACK	GROUND
32.	BLACK	GROUND
33.	GREEN	LEVEL SENSOR +5-
34.	BLACK	GROUND-
35.	YELLOW	BUTTON (TO LEVEL SWITCH)-
36.		
37.	VIOLET	COMMUNICATION (TO LEVEL SWITCH)-
38.		
39.	BLACK	
40.	WHITE	TX-
41.	YELLOW	RX-
42.	BLACK/WHITE	+ 12V WORKING ENGINE (+AT FUEL PUMP) CN-
43.	GREEN	VACUUM INL-
44.	ORANGE	TERMOSENSOR ADC4-
45.	VIOLET	LAMBDA SENSOR ADC1-
46.	BLUE	PRESSURE 1 ADC3-
47.	WHITE	LEVEL SENSOR ADC2-
48.	BLACK/ORANGE	TERMOSENSOR TO GAS INJECTOR IN PL-
49.	BLACK	GROUND MAP
50.	WHITE	K LINE
51.	BLACK/GREEN	L LINE
52.	YELLOW	CAN HIGH
53.	RED	MAP SENSOR SUPPLY VOLTAGE OUT12V
54.	BLACK/YELLOW	CAN LOW
55.	VIOLET	CUT PETROL INJECTOR 8 TO PETROL INJECTOR CUT8_A
	VIOLET	CUT PETROL INJECTOR 8 TO CAR'S ECU CUT8_B

files with the data about the client are automatically generated like "CAR MAKE MODEL_PLATE NUMBER (for example OPEL_VECTRA_CA1234XB) which data you can change for your needs. The fails are with extension *.CNT and they are saved in subdirectory "CLIENT'S DATA". On the time of maintenance of the LPG/CNG systems you can open the fails by button "CLIENT'S DATA" and to refer the adjustment for the car and the client's data – like "kilometres", "installing data" etc.

MAP

The system has an option to work with the three size "MAP" – it is the function of the coefficients depending from the revolutions and engine load – ms.

To work with the map, you have to switch to menu "MAP" (Pic.7.) and the check box "WORK with MAP". There is also a red point, which is dynamic, signing the three parameters at the present moment. The change of the cell of the map or square of cells you can make by mouse marking (with blue colour) and pushing "ENTER". You will see the small menu for type of modification of coefficients – linear, percentage and adding of value. These values in the map could be from 1.00 to 2.50. Each of the time when you change some cells, the system is working with these coefficients, you have to save them by pushing "SAVE".

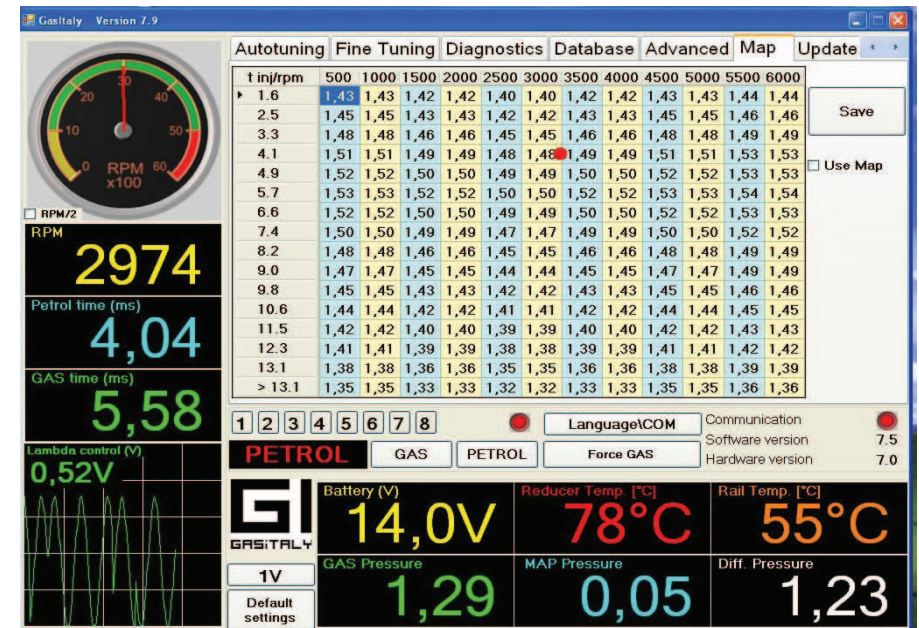

Pic.7 MAP

ADVANCED 1 / ADVANCED 2

1. RPM for automatic turnover from gas to petrol. (Pic. 8) The system allows to turn over from GAS to petrol over given by slider (2000-8000 RPM). If the running on petrol car goes under the chosen RPM, the ECU turnover automatically to LPG or CNG. This function is switched off when slider is in right end position.

2. Cycles on petrol when engine go out from "cut-off". (ADVANCED 2, Pic.9) Some engines have drop out of RPM when go out in "cut-off" regime, so some cycles you can programm (from 0-7) to feed with petrol - it is helpful to keep the RPM over 500. This function is switched off when 0 is chosen.

3. Level sensor. (Pic.8) From this menu you can choose type of sensor and also adjust all 4 levels by sliders. Moving non standard type sensor you could adjust all 4 levels, measured in volts. On the screen are shown the LED-s from the switch - petrol, gas, reserve, 1/4, 1/2, 3/4,. When the level from multivalve is increasing and the voltage from the sensor is decreasing, you have to choose "Non standard reverse sensor" The adjustment procedure is the same.

On the bottom figure you could choose pressure sensor type, by the slider you could choose the RPM when the cold engine starts automatically on gas, it is for the problem cars only for first switch-over. Basically this function is switched off.

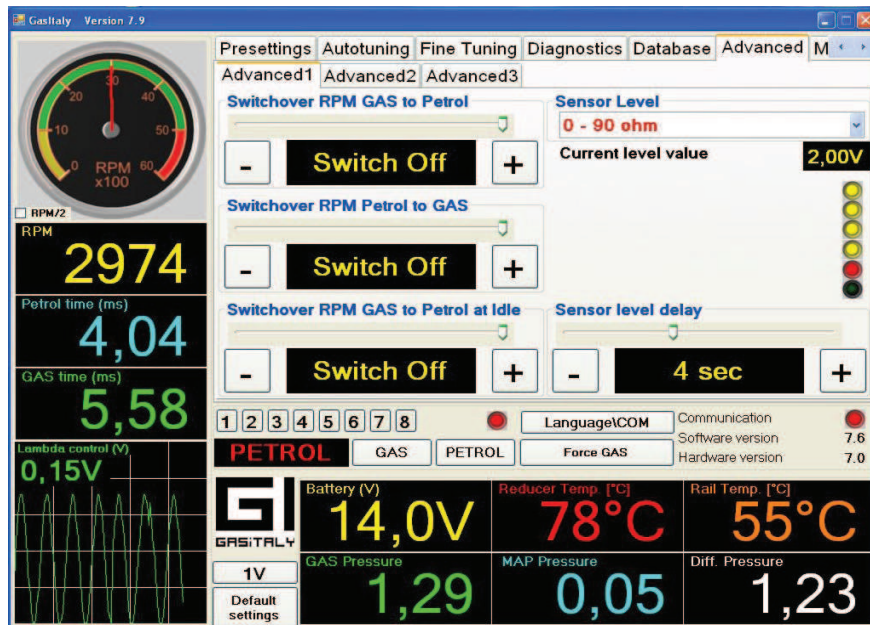

Pic. 8 Advanced settings 1

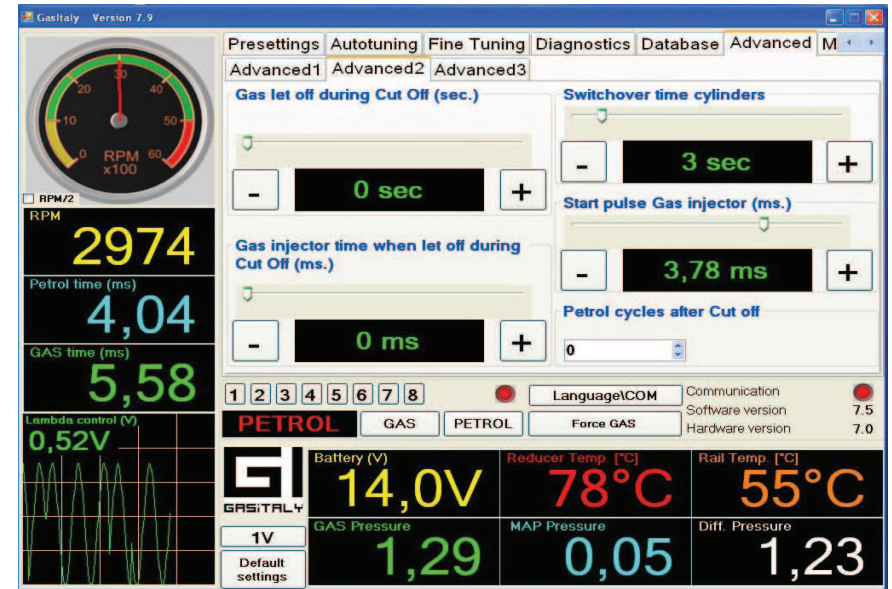

Pic. 9 Advanced settings 2

On "ADVANCED 2" screen there is a very special function, which could be adjusted - Gas injector start pulse length (Pic 9, right). For the injectors with different coil resistance (1, 1.5, 2, 3ohm) the length of the start impulse must be precisely adjusted, so by this slider you could readjust the necessary time for correspond coil resistance (basically in the system are given 3 ohm coils and factory set time is 3.78ms., you don't need to use this function). For some cars with very short petrol injector times (up to 2.2ms) the coils could be changed with 1.5 or 2ohm coils) in this case the system performance could be better. The times to be chosen are as follow: 1ohm - 2.5ms; 1.5 - 2.8ms; 2ohm - 3.2ms.

On the "ADVANCED 2" menu in the left side of the screen there are two sliders, which allow to decrease gas pressure after continuous "CUT OFF" mode for the engine, or for the "turbo" engines, which consume a lot of gas, also for the cars with big power (over 150 PS) with automatic transmissions, which are put often in "kick down" mode. First slider determines how much seconds you have to let the gas off. (Sometimes if you choose the times over 5 sec., the petrol ECU could light the "Check engine" lamp, so this function must be used very carefully. The second slider is used to adjust the length of the let off cycle.)

Sometimes in cold weather (under 10°C) the injectors need to be moved primary to be ready to work properly till became warmer, so there is procedure for regulation - the time in sec. for switching each cylinder on gas. This could be made by slider in down right corner of the screen (Pic. 9). In the same time

for first turn over from petrol to gas it is provided possibility for adjustment of the RPM when is done.

In **ADVANCE 3** menu there is an option to choose at what temperature to start the engine directly on GAS. by slider 46.

With slider 47 you can adjust minimum gas time for engines with not stable RPM at idle mode. For the most popular injectors VALTEK and RAIL or similar this time is 3.8ms

48 - slider - specific setting for non standard injectors (10 Ohm without PWM). Use factory settings 40% +/- 2%.

49 - Simultaneously turn-over all cylinders from petrol to LPG/CNG. This function is helpful for some cars with "full group" injector system, because all petrol injectors could not be interrupted separately.

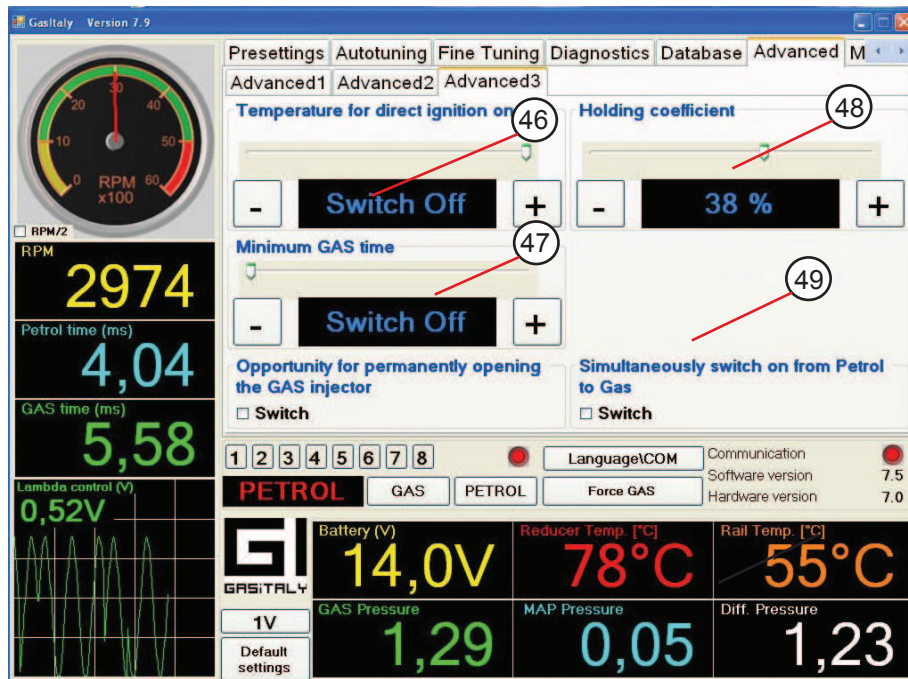

Pic. 9a Advanced settings 3

OBD/ CAN communication modul /only for ECU with OBD version/

This chapter will give more information about the OBD/ CAN communication modul and will direct to easy adjustment of the system.

First of all you could see two screens in the menu "**Diagnostics**" - "**OBD parameters**" (Pic.11) and "**Errors**" (Pic.12) . When the instalation of the wires, used for OBD/CAN connection are properly spliced to the back wires of the car's 16-pin diagnostic connector, running the software you have to connect gas ECU by pushing the button "OBD connect". After a few seconds you will see a message "OBD connected". By pushing some of the red buttons you could see the moment value of some important parameters, reading from the petrol ECU. The most important ones are "Short fuel trimmer and "Long fuel trimmer" (in %), which correspond to the right adjustment of the system. For convenience you will see these parameters also on the proper place in the menu "PRESETTINGS". Shortly you have to know, that you need to keep them near to 0%. If their values are very different from 0% at petrol, you need to read just the coefficients in gas mode so, that the values of these both parameters have to be equal to them in petrol mode (for instance at petrol mode they are +18%, adjust the coefficients this way, they are near +18% in gas mode). Here is the place to mention what these two parameters mean. If they are permanently positive (+.%) ,it means the fuel mixture is too lean and the petrol ECU will try to encrease the injection times to compesate this. If the sign for them is most the time negative, the mixture is

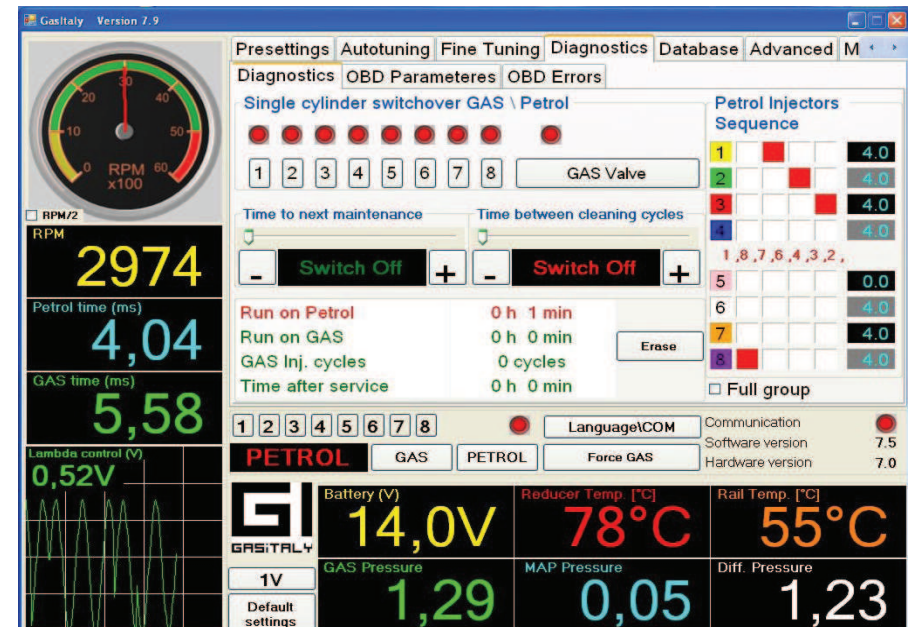

Pic.10 Diagnostics

rich. Most often these parameters are positive when the petrol injectors are dirty or negative when the car is run over 100 000 km or the air filter is dirty.

Analyzing these parameters you could find some problems in the gas system in whole. For instance after 30-60 thousand km melege the gas injectors increase the flow rate, so the gas ECU make the fuel mixture rich and the "short and long fuel trimmer" became negative. In this case you have to readjust the coeff. properly.

Looking other parameter (for inst. Intake pressure), you could control the proper work of the MAP sensor.

The other mode in the menu "Diagnostics" is "Errors". Using this menu, you could read, analyze and clear all errors, established on the time of installing, adjusting and using the gas system any time. **NOTE:Here is important to inform you, that you have to clear the errors after carefull analisys. In some countries it is forbidden to do this. So you must to be very careful with this feature!**

It is very useful to make easy diagnostic, using our system software when you make maintenance control for the gas system at all.

There are two new windows in the screen "Diagnostic", which will give you statistic information about the hours the car is run on petrol, on gas, also the cycles gas injectors are run, the hours left to the profilactic and maintenance. Here you could see two different times - from the very begining and from the last control. It is useful for the installers to control the waranty and the elapsed time for the filter's change. There is slider for adjusting of the the time to maintenance in hours. It is established also the feature, which allows to clean the petrol

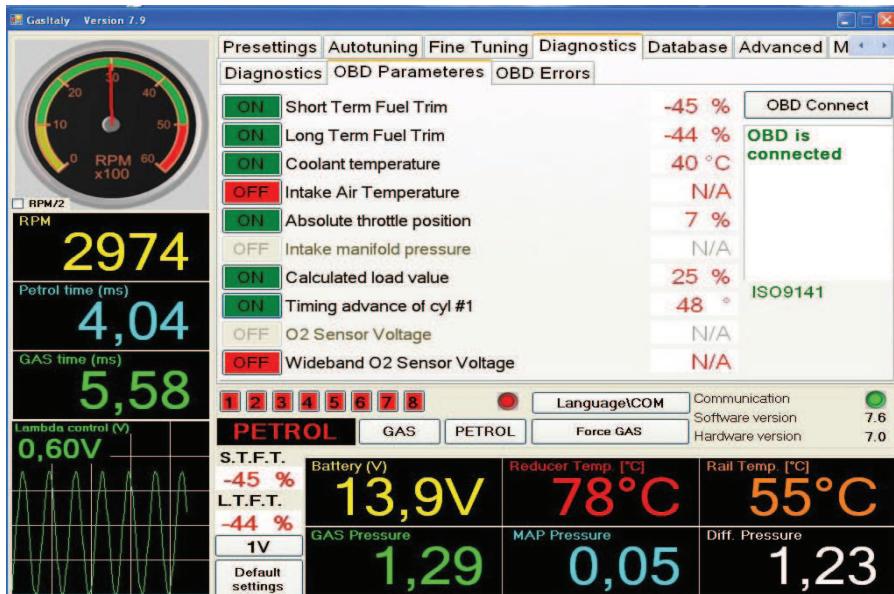

Pic. 11 OBD parameters

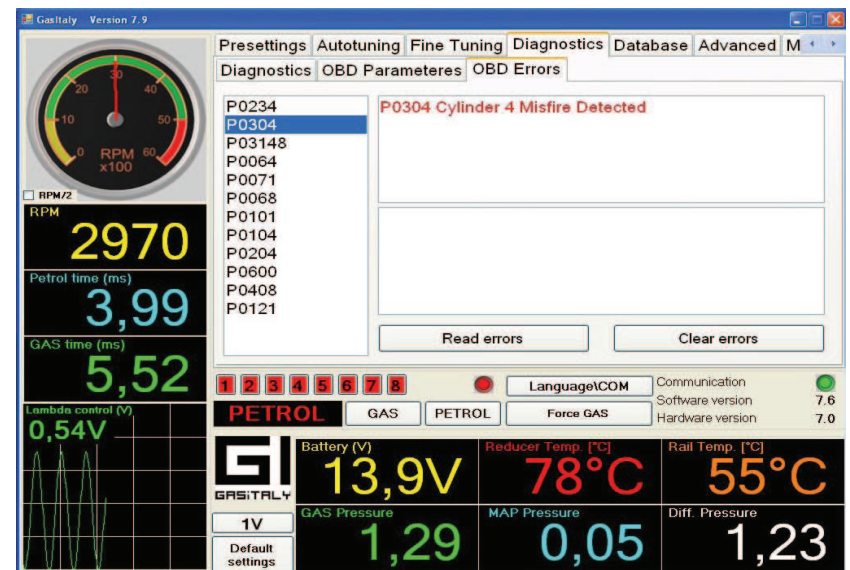

Pic. 12 OBD Errors

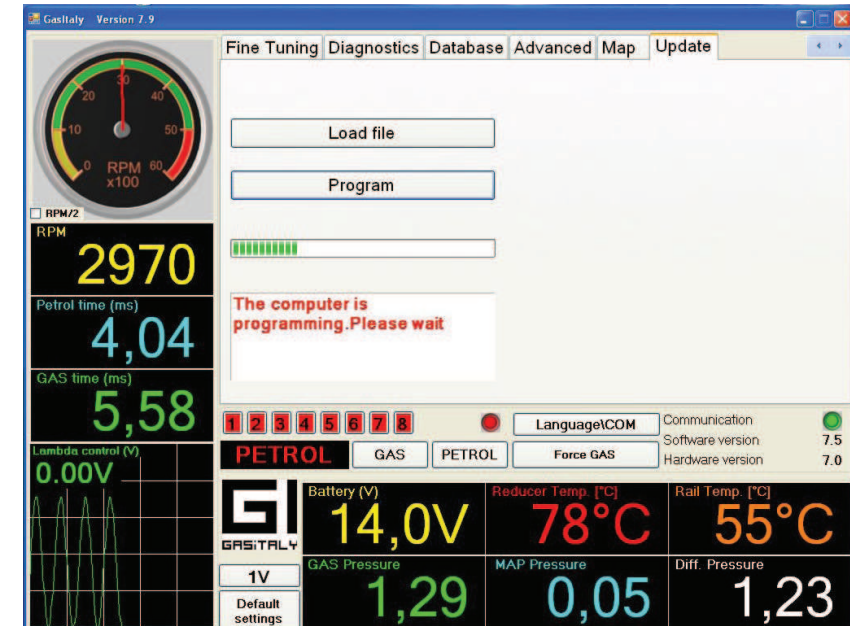

Pic. 13 UPDATE

Menu for update of factory software. You must have new exe file. Follow menu intructions.

injectors automatically on the time the machine is running on gas. This is very useful for the cars with very big mileage, such as taxi cars or fast courier cars. There is slider, which adjust the period between one minute petrol cleaning

SOME USEFUL HINTS

These notes will give you information about the possibility to adjust the system, installed on the cars with some special features, like "full group", short injection times etc.

First we need to explain the thresholds, where the system working properly. For the coefficients they are between 1.0 and 2.5. It means, that all the petrol injection times will be multiplied with these values. For instance if the current coeff. is 1.8 and the petrol time at idle is 1.9ms, the gas injection time will be 3.42ms. Here is the place to inform, that the injectors work properly with times between 4.0 and 24ms. So you could see from upper exercise how the system could be adjusted out of range of proper work. All the good adjustment is related to proper combination between nozzle's size, multiply coeff., reducer pressure and map adjustment. Every time the long hoses (over 25 cm.) and the remote drilling into manifold (more than 3cm.) away from petrol injectors are not permitted due to avoid unstable work at idle. Let us to see one exercise – for instance BMW 2.5i car old model – full group, 1994, 6 cyl., 192 PS., automatic transmission. According to table for the nozzle sizes, we could choose 2 mm nozzle. Because this car is "full group" car, by check box on the diagnostic screen we switch to this mode. In this case we increase the nozzle size to 2.5 mm and start the auto-tuning mode. If the self-adjusting is OK, the owner could test the car on the road in all regimes – middle speed, big speed with low rpm, kick-down mode of the transmission, etc. Often in the high rpm mode (over 4500 rpm) the engine need more fuel, so you could increase the coefficients near the place of the blue band – current injection time. Every time we have to be careful with the value of the gas times (green) – not more 22- 24 ms at 5000 rpm. Sometimes for better performance we could switch over 5000-5500 rpm by slider engine to work on petrol. If the auto-tuning mode doesn't pass OK, we could adjust the system manually, switching the check box " manual adjustment". In this case follow the manual recommendations. For many reasons the software could give the message in the note screen (red color) which is not correct (big nozzles, etc.), we adjust the coefficients according to good work of the engine.

Sometimes, for the cars with bigger power and especially with automatic transmission (40-60 PS/cylinder), we need to increase the coefficients for middle and high loads (over 8-10 ms) with 10-40 % at least, so in this way the coeff. curve on the "Fine tuning" screen become with smaller slope and even horizontal flat. It is make by automatic calibration (self tuning) and later manually.

For the "full group" cars with small petrol injector times (less than 2.2ms) you have to be careful how to choose the calibrating nozzles, to ensure coeff. at idle at least 1.9 – 2.1. Because in "full group" mode we inject the gas two times

less than petrol, the nozzles must be at least two sizes bigger, than in normal mode (the check box "full group" on the diagnostic screen must be switched on). In these cars could be seen other problem – at high speed, big rpm (over 4500) and TPS over 50-60% the bad, interrupting performance of the engine is seen. It is because of the totally open gas injectors at this regime. It could be avoid by decreasing of multiply coeff. (the gas times must be under 22-24 ms at 5500-6000rpm). It is going against the requirement for the big coeff. at idle, so we need to find the right "middle". In these cases sometimes is more difficult to stabilize the rpm at idle. Very rarely we have to do this by using more fast injectors (with opening time not more, than 2.5ms – the standard ones are around 3.5-4 ms.) If it is not possible, the MAP adjustment could be useful. We have to adjust the system by auto-tuning procedure, after that by buttons "Calculate MAP" and "Use MAP" we open the MAP screen, where it is seen the red point, moving into 4-6 fields. Marking them, changing the values up or down between 10-20% we could stabilize the rpm at idle. Very often the length of the pipes to manifold have to be shortened less, than 20 cm. to stabilize the idle rpm.

WARRANTY CARD

Warranty time: 24 months or 50 000 km.

Serial Number

Distributor

Signature

Car brand Number

Drived kilometers since the installing

Owner

Data of the installing

Name & signaller of the installer

Warranty terms:

The warranty is only about fabric defects accured during manufacturing which have accured in the waranty time. Repairs and installing are made only by AUTHORIZED COMPANY EXPERTS!

The warranty is not about damages from not keeping the safety use instructions, mechanical damages and floods in the module. In these cases the warranty is no longer valid and repairs can be done.